

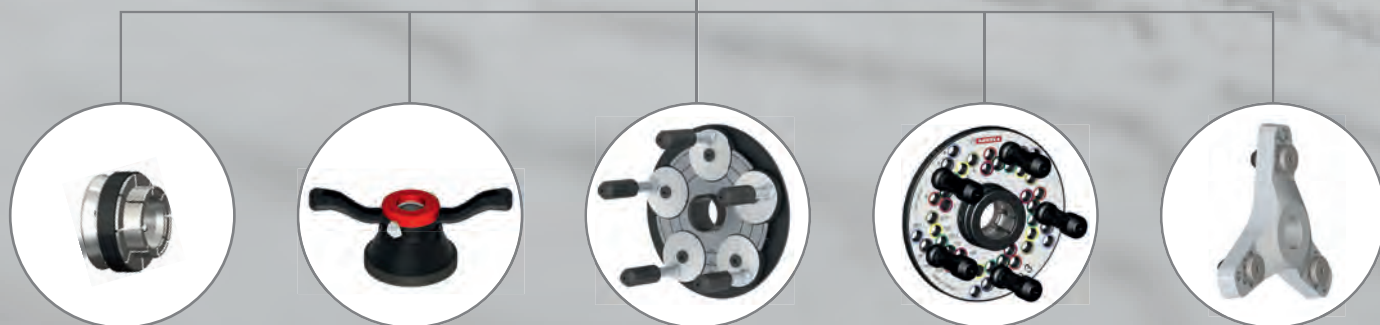

UCHWYTY MOCUJĄCE - CENNIK 2022

V 1.0



Mimo naszych starań, przy tak dużej ilości wpisów trudno uniknąć błędów.
Zastrzegamy sobie prawo do przypadkowo popełnionych błędów, zobowiązując się
do ich natychmiastowej korekty.









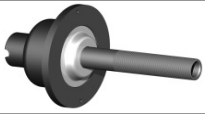
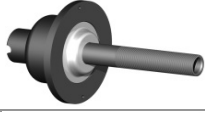
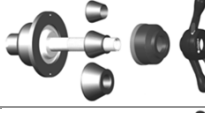
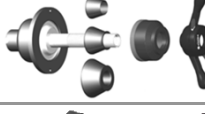

Aktualny stan: 30.05.2022

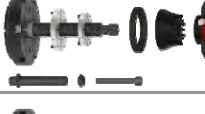













Ten cennik obowiązuje od 01.07.2022 i zastępuje wszelkie poprzednie, które
automatycznie tracą ważność.















Wersja: V1.0 / 2022

HAWEKA AG

Kokenhorststraße 4
30938 Burgwedel
Germany















Kod	Art.-Nr.	Nazwa	Cena
Uchwyty główne / Zestawy adapterów			
Łącza			
	A 100e818 028	Korpus uchwyty stożkowego Tr 40x4, ukryta sprężyna, 240 mm	580,00 €
	A 100e818 040	Korpus uchwyty stożkowego Tr 40x3, ukryta sprężyna, 240 mm	580,00 €
	A 104 818 038	Uchwyt główny Tr 40x3, 3 stożki, ProGrip, 200 mm	887,00 €
	A 104 818 131	Uchwyt główny Tr 40x4, 3 stożki, ProGrip, 240 mm	918,00 €
	A 104 818 132	Uchwyt główny Tr 40x3, 3 stożki, SoftGrip, 240 mm	918,00 €
	D 105 447 004	QuickHub Uchwyt główny Tr40x3, SoftGrip Bright	1.560,00 €
	D 105 589 004	QuickHub Uchwyt główny Tr40x3, SoftGrip Pneumatyka: Cemb Ø40 / Hofmann Megaplan / TipTop	1.560,00 €
	D 105 589 005	QuickHub Uchwyt główny Tr40x3, SoftGrip Cemb Ø40 / Hofmann Megaplan / TipTop	1.560,00 €
	D 105 618 004	QuickHub Uchwyt główny Tr40x3, SoftGrip Hunter GSP / DSP Serie	1.560,00 €
	D 105 657 004	QuickHub Uchwyt główny Tr40x3, SoftGrip Mondolfo MT-3750	1.560,00 €
	D 105 818 004	QuickHub Uchwyt główny Tr40x3, SoftGrip do wyważarek ze stożkowym łączem	1.560,00 €
	D 105 907 004	QuickHub Uchwyt główny Tr40x3, SoftGrip Corghi Ø40 PN+Standard	1.560,00 €
	D 105 957 004	QuickHub Uchwyt główny Tr40x3, SoftGrip JBC, Hofmann z cylindrycznym połączeniem >= 2014	1.560,00 €
	D 100e008 036	QuickHub Zestaw przedłużający (6 szt./zestaw) nr. 4 (147,9 - 171,5 mm)	231,00 €
	D 100e008 037	QuickHub Zestaw przedłużający (6 szt./zestaw) nr. 3 (123,5 - 147,1 mm)	231,00 €

Kod	Art.-Nr.	Nazwa	Cena
ProGrip Kit i Adapter Kit			
	A 124 283 000	ProGrip Kit Tr 28,55x3 zawiera 143 283 003 / 190 008 002 / 190 008 005	178,00 €
	A 124 283 001	ProGrip Kit Tr 28.55x3 zawiera 143 283 006 / 190 008 002 / 190 008 005	178,00 €
	A 124 363 000	ProGrip Kit Tr 36x3 zawiera 143 363 003 / 190 008 002 / 190 008 005	178,00 €
	A 124 383 000	ProGrip Kit Tr 38x3 zawiera 143 383 003 / 190 008 002 / 190 008 005	178,00 €
	A 124 403 000	ProGrip Kit Tr 40x3 zawiera 143 403 003 / 190 008 002 / 190 008 005	178,00 €
	A 124 405 000	ProGrip Kit Tr 40x4 zawiera 143 405 003 / 190 008 002 / 190 008 005	178,00 €
	A 124 408 005	ProGrip Kit Tr 40x8,46 zawiera 140 408 033 / 190 008 002 / 190 008 005	315,00 €
	A 124 589 030	Adapter Cemb & TipTop Tr 40x4 wałek, 3 stożki, ProGrip Kit	453,00 €
	A 124 627 037	Adapter Fasep 3 stożki, ProGrip Kit, wałek Tr 40x3 (bez 190 008 005)	453,00 €
	A 124 907 032	Adapter Corghi / Sice / Faip Tr 38x3, wałek, 3 stożki, ProGrip Kit	453,00 €
	A 124 907 231	Adapter Mondolfo, Corghi, HPA, wałek Tr 40x3, ProGrip Kit 3 stożki, kołpak	453,00 €
	A 124 957 033	Adapter Balco / Haweka Tr 40x3, wałek, 3 stożki, ProGrip Kit	453,00 €
	A 124 958 036	Adapter John Bean/Hofmann (> 2014) Serie 9000 Tr 40x3, wałek, 3 stożki, ProGrip	453,00 €
	A 125 447 000	Adapter Bright / Cormach Tr 40x4, wałek, 3 stożki, SoftGrip	453,00 €

Kod	Art.-Nr.	Nazwa	Cena
Nakrętki szybkomocujące / akcesoria			
	C 125 403 000	SoftGrip Satz Tr 40x3 zawiera SoftGrip 144 403 000 i 190 008 065 / 190 008 005	151,00 €
	C 125 404 000	SoftGrip Satz Tr 40x4 zawiera SoftGrip 144 404 000 i 190 008 065 / 190 008 005 (HAWEKA)	151,00 €
	C 125 405 000	SoftGrip Satz Tr 40x4 zawiera SoftGrip 144 405 000 i 190 008 065 / 190 008 005	151,00 €
	C 125 408 000	SoftGrip Satz Tr 40x8,46 P2 zawiera SoftGrip 144 408 000 i 190 008 065 / 190 008 005	151,00 €
Nakrętki szybkomocujące (wersja stal)			
	A 140 403 033	Nakrętki szybkomocujące Tr 40 x 3 mm	288,00 €
	A 140 405 033	Nakrętki szybkomocujące Tr 40 x 4 mm	288,00 €
	A 140 408 033	Nakrętki szybkomocujące Tr 40 x 8.46 mm	288,00 €
	A 140 466 003	Nakrętki szybkomocujące Tr 46 x 6 mm Corgi Lkw	453,00 €
Nakrętki szybkomocujące ProGrip (wersja PA)			
	A 143 283 003	ProGrip Tr 28,575 x 3 mm	148,00 €
	A 143 283 006	ProGrip Tr 28,575 x 3 mm, z pokrętłami	148,00 €
	A 143 285 003	ProGrip Tr 28,575 x 3,5 mm	148,00 €
	A 143 285 006	ProGrip Tr 28,575 x 3,5 mm z pokrętłami	148,00 €
	A 143 363 003	ProGrip Tr 36 x 3 mm	148,00 €
	A 143 363 006	ProGrip Tr 36 x 3 mm z pokrętłami	148,00 €
	A 143 383 003	ProGrip Tr 38 x 3 mm	148,00 €













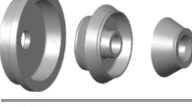

-- ** -- = Cena do uzgodnienia
A B C D N = Grupy rabatowe

V1.0 2022

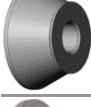
Kod	Art.-Nr.	Nazwa	Cena
	A 143 383 006	ProGrip Tr 38 x 3 mm z pokrętłami	148,00 €
	A 143 403 003	ProGrip Tr 40 x 3 mm	148,00 €
	A 143 403 006	ProGrip Tr 40 x 3 mm z pokrętłami	148,00 €
	A 143 405 003	ProGrip Tr 40 x 4 mm	148,00 €
	A 143 405 006	ProGrip Tr 40 x 4 mm z pokrętłami	148,00 €
	A 143 408 003	ProGrip Tr 40 x 8,46 mm Hunter Serie 9200	148,00 €
Nakrętki szybkomocujące SoftGrip			
	C 144 403 000	SoftGrip Tr 40 x 3 mm	124,00 €
	C 144 403 001	SoftGrip Tr 40 x 3 mm z pokrętłami	124,00 €
	C 144 404 000	SoftGrip Tr 40 x 4 mm (HaweKa)	124,00 €
	C 144 404 001	SoftGrip Tr 40 x 4 mm z pokrętłami (HaweKa)	124,00 €
	C 144 405 000	SoftGrip Tr 40 x 4 mm Hofmann	124,00 €
	C 144 405 001	SoftGrip Tr 40 x 4 mm z pokrętłami, Hofmann	124,00 €
	C 144 408 000	SoftGrip Tr 40 x 8,46 mm Hunter Serie 9200	124,00 €
	C 144 408 001	SoftGrip Tr 40 x 8,46 mm z pokrętłami Hunter Serie 9200	124,00 €
		Stożki / Pierścienie centrujące / Pierścienie stożkowe / Rączki dociskowe	
		Zamiast XX na 4 i 5 miejscu w numerze należy podać średnicę wałka wyważarki (28, 30, 35, 36, 38, 40)	
	A 150 xx0 008	Stożek Ø40 = 44 - 64,7 mm	44,00 €















-- ** -- = Cena do uzgodnienia
A B C D N = Grupy rabatowe









V1.0 2022



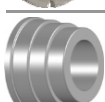
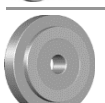









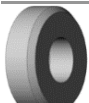

Kod	Art.-Nr.	Nazwa	Cena
	A 150 xx0 009	Stożek 54 - 79,5 mm	58,00 €
	A 150 xx0 011	Stożek 44 - 80 mm	58,00 €
	A 150 xx0 012	Stożek 74 - 111,5 mm	69,00 €
	A 150 xx0 020	Zestaw 2 - stożków 44 - 111,5 mm (011 / 012)	119,00 €
	A 150 xx0 022	Stożek 168,5 - 194,5 mm	321,00 €
	A 150 xx0 024	Stożek 198 - 225 mm / stosować tylko z tarczą dystansową 190 xx0 042	229,00 €
	A 150 xx0 025	Stożek do sam.Cięż. 277,4 - 283 mm	292,00 €
	A 150 xx0 026	Zestaw stożków do lekkich sam. Cięż. 95-174 mm (043 / 049 / 190 xx0 018)	321,00 €
	A 150 xx0 043	Stożek 122 - 174 mm	142,00 €
	A 150 xx0 048	Stożek 68 - 98 mm	90,00 €
	A 150 xx0 049	Stożek 95 - 132 mm	90,00 €
	A 150 xx0 072	Stożek 137 - 140,5 mm, Ford Transit od 1995	178,00 €
	A 150 xx0 074	Stożek 128 - 131,5 mm, Iveco od 1997	178,00 €
	B 15U 400 082	Zestaw 7- stożków 42,5 - 131,5 mm	322,00 €
	A 150 xx0 085	Zestaw 3 - stożków 44 - 111,5 mm (008 / 009 / 012)	165,00 €
	A 150 xx0 091	Stożek 122-174 mm (043 / 190 xx0 018)	248,00 €

-- ** -- = Cena do uzgodnienia
A B C D N = Grupy rabatowe













V1.0 2022











	Kod	Art.-Nr.	Nazwa	Cena
	A	150 xx0 092	Stožek 100-118 mm	109,00 €
	B	150 xx0 095	Zestaw 4- stożków 43-110 mm	193,00 €
	A	150 xx0 111	Low-Taper Stożek 52,5 - 62,0 mm # 1	66,00 €
	A	150 xx0 112	Low-Taper Stożek 61,5 - 70,0 mm # 2	73,00 €
	A	150 xx0 113	Low-Taper Stożek 67,5 - 76,0 mm # 3	79,00 €
	A	150 xx0 114	Low-Taper Stożek 75,0 - 83,0 mm # 4	85,00 €
	A	150 xx0 115	Low-Taper Stożek 82,0 - 90,5 mm # 5	90,00 €
	A	150 xx0 116	Low-Taper Stożek 89,0 - 97,5 mm # 6	98,00 €
	A	150 xx0 117	Low-Taper Stożek 94,0 - 103,0 mm # 7	106,00 €
	A	150 xx0 118	Low-Taper Stożek 101,0 - 111,0 mm # 8	112,00 €
	A	150 xx0 119	Low-Taper Stożek 110,0 - 122,0 mm # 9	125,00 €
	A	150 xx0 110	Zestaw 9- Low-Taper stożków 52,5 - 122 mm	779,00 €
	A	150 xx0 121	Zestaw 8-Low-Taperstożków 52,5 - 110 mm	660,00 €
	A	150 xx0 130	Zestaw 5-Low-Taperstożków 52,9 - 90,5 mm	382,00 €
			Tuleje centrujące	
			Zamiast XX na 4 i 5 miejscu w numerze należy podać średnicę wałka wyważarki (28, 30, 35, 36, 38, 40)	
	A	160 xx0 004	Tuleja centrująca 63.25 / 63.5 mm	120,00 €









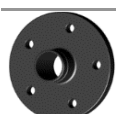
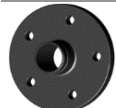





	Kod	Art.-Nr.	Nazwa	Cena
	A	160 xx0 006	Tuleja centrująca 58 / 65 mm	120,00 €
	A	160 xx0 008	Tuleja centrująca OPEL 56.5 / 65 mm	120,00 €
	A	160 xx0 011	Tuleja centrująca 55/60/65 mm	120,00 €
	A	160 xx0 012	Tuleja centrująca 54/60/64 mm	120,00 €
	A	160 xx0 017	Tuleja centrująca General Motors USA 57/70,5/78 mm	120,00 €
	A	160 xx0 038	Tuleja centrująca BMW/ Ford (USA) 63.6-64.4 / 72.1-73 mm	120,00 €
	A	160 xx0 048	Tuleja centrująca 142 mm Renault Master III / Trafic / Opel Movano	338,00 €
	A	160 xx0 055	Tuleja centrująca Renault / Dacia 59-60 / 66 / 71 mm	120,00 €
	A	160 xx0 056	Tuleja centrująca Crafter / Sprinter 161 mm	338,00 €
	A	160 xx0 059	Tuleja centrująca 130 mm IVECO Daily / Renault Master II	338,00 €
	A	160 xx0 060	Tuleja centrująca Ford/KIA/Hyundai (USA) 86.4-87.3 / 91-96 mm	134,00 €
	A	160 xx0 061	Tuleja centrująca Land Rover 72.5 mm	120,00 €
	A	160 xx0 062	Tuleja centrująca Off Road (USA) 99-101,5 / 106 - 110,7 mm	134,00 €
	A	160 xx0 063	Tuleja centrująca Off Road Off Road 66,5-67,5 / 71 - 72 mm	120,00 €
	A	160 xx0 064	Tuleja centrująca Dodge / Chrysler 73.6 - 74.6 / 77 - 78.5 mm	120,00 €
	A	160 xx0 065	Docisk Porsche Felgi ø71,58 + GT/TURBO ø84	38,00 €
	A	160 xx0 069	Tuleja centrująca BMW ø56-57/72,5-74mm	120,00 €













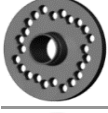
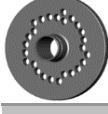

	Kod	Art.-Nr.	Nazwa	Cena
	A	160 xx0 070	Tuleja centrująca 65/66,5/84mm VW / Mercedes	120,00 €
	A	160 xx0 071	Tuleja centrująca 60/57mm VW / Mercedes / Smart	120,00 €
	A	160 xx0 072	Tuleja centrująca BMW ø66,5mm (model od 2013)	120,00 €
	A	160 xx0 073	Tuleja centrująca Renault Twizy ø60,1mm	120,00 €
	A	160 xx0 074	Tuleja centrująca Porsche ø71,58 + GT/TURBO ø84 + Macan	120,00 €
Zestawy centrujące do felg szprychowych				
	B	162 400 040	Zestaw do felg szprychowych z centralnym zamkiem, 40/52 mm, kompletny	244,00 €
	B	162e400 001	Stożek Astin Martin DB 6, Jaguar, Triumph, Austin Healy	120,00 €
	B	162e400 002	Pierścień centrujący, stożkowy Jaguar, Triumph, Austin Healy	179,00 €
	B	162e400 003	Pierścień centrujący, stożkowy Aston Martin DB 6, stary Jaguar	179,00 €
DuoExpert				
DuoExpert - Serie III				
	A	165 400 005	DuoExpert III System, 3 tuleje w walizce 54-78 mm.	889,00 €
	A	165 400 001	DuoExpert Tuleja I, 54-62 mm	311,00 €
	A	165 400 002	DuoExpert Tuleja II, 62-70 mm	311,00 €
	A	165 400 003	DuoExpert Tuleja III, 70-78 mm	311,00 €
	A	165 400 006	DuoExpert Tuleja IV, 78-86 mm	311,00 €
	A	165 400 004	DuoExpert Tuleja V, 86-94 mm	336,00 €









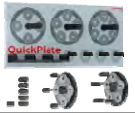

Kod	Art.-Nr.	Nazwa	Cena
Wałki gwintowane			
	A 170 589 001	Wałek gwintowany Tr 40x4mm Cemb & TipTop 190 mm, Śruba M10	211,00 €
	A 170 618 001	Wałek gwintowany Tr 40x8,46 P2, 250 mm long, Hunter GSP/DSP 9200+GSP9720	311,00 €
	A 170 627 011	Wałek gwintowany Tr 40x3 mm Fasep / RAV, 225 mm, Anschluss M22 x 1,5	211,00 €
	A 170 907 007	Wałek gwintowany Tr 40x3 Mondolfo 181 mm	211,00 €
	A 170 958 006	Wałek gwintowany Tr40x3 für John Bean/Hofmann (> 2014) serie 9000, 300 mm długi	311,00 €
Kołpaki / Tarcze dystansowe & Sprężyny			
Zamiast XX na 4 i 5 miejscu w numerze należy podać średnicę wałka wyważarki (28, 30, 35, 36, 38, 40)			
	A 190 008 002	Kołpak pasujący do wszystkich nakrętek ProGrip	43,00 €
	A 190 008 005	Nakładka gumowa kołpaka 190 008 002	11,50 €
	A 190 008 021	Duży (Ø 220mm) kołpak do felg Alu. Pasuje do nakrętek Haweka ProGrip	86,00 €
	A 190 400 021	Duży (Średnica Ø 220mm) kołpak do felg Alu. Do średnic wału Ø 40 mm	103,00 €
	A 190 008 027	Pierścień dociskowy, pasujący do wszystkich nakrętek ProGrip	11,50 €
	C 190 008 065	Kołpak pasujący do wszystkich nakrętek SoftGrip	32,00 €
	A 190 400 015	Sprężyna stożkowa do otwartych uchwytów głównych, DuoExpert	11,50 €
	A 190 658 001	Stalowy pierścień dystansowy Mondolfo	277,00 €
	A 190 905 001	Stalowy pierścień dystansowy Corghi	277,00 €
	A 190 958 001	Stalowy pierścień dystansowy John Bean/Hofmann (> 2014)	277,00 €





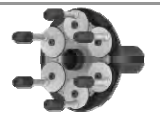
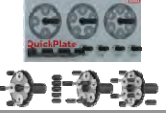





Kod	Art.-Nr.	Nazwa	Cena
	A 190 988 002	Stalowy pierścień dystansowy Cemb / Haweka	277,00 €
	A 190e008 047	Pierścień dystansowy (36 mm) z magnesami do felg OFF-Road z bolcami	247,00 €
	A 190 008 062	Pierścień dystansowy (15 mm) z magnesami do felg OFF-Road z bolcami	181,00 €
	A 190 xx0 010	(Polyamid) Pierścień dystansowy DuoExpert	16,00 €
	A 190 xx0 018	Tarcza dystansowa ALU	172,00 €
	A 190exx0 045	Polyamid Docisk do felg Off-Road	21,00 €
Płyty dociskowe WORLD KIT			
Zestawy płyt z serii WORLD KIT II (Ø 11 mm)			
<small>Zamiast XX na 7 i 8 miejscu w numerze należy podać średnicę wałka wyważarki (28, 30, 35, 36, 38, 40)</small>			
	A 200 018 xx5	Profi-Set: 4 Płyty- kolorowane, zawiera 3 komplety bolców, 1 tablicę ścienną, tabelę, CD Rom	1.485,00 €
	A 203 018 xx5	Profi-Set: 4 Płyty- kolorowane, zawiera 3 komplety bolców, 1 tablicę ścienną, tabelę, CD Rom do Hofmann PC / JBC PC / Bosch P / Sicam P / Beisbarth P	2.038,00 €
	A 205 018 xx5	Profi-Set: 4 Płyty- kolorowane, zawiera 3 komplety bolców, 1 tablicę ścienną, tabelę, CD Rom do Cemb P/ Hofmann Megaplan P/ Corghi P /Mondolfo P/Tip Top Propalance P	2.038,00 €
Osobne płyty z serii WORLD KIT II (Ø 11 mm)			
	A 241e901 xx9	Płyta centrująca, (TSP Nr. 1) kolorowana bez bolców 4x95,25/ 4x98/ 4x100/ 4x101,6/ 4x108/ 4x114,3/ 7x150/ 4x170 / 4x180	271,00 €
	A 251e801 xx9	Płyta centrująca (TSP Nr. 2) kolorowana bez bolców 5x98/ 5x105/ 5x108/ 5x110/ 5x115/ 5x120,65/ 5x135/ 5x154,95	271,00 €
	A 251e901 xx9	Płyta centrująca (TSP Nr. 3) kolorowana bez bolców 5x100/ 5x112/ 5x114,3/ 5x120/ 5x127/ 5x130/ 5x139,7/ 5x150/ 5x165,1	271,00 €
	A 231e111 xx9	Płyta centrująca (TSP Nr. 4) Off Road, kolorowana bez bolców 3x98/ 3x112/ 3x114,3/ 3x115/ 3x120/ 3x127/ 3x130/ 3x132,7/ 6x135/ 6x139,7/ 4x165,1	271,00 €

Kod	Art.-Nr.	Nazwa	Cena
		Rączki dociskowe do maszyn pneumatycznych należy domówić osobno!	
	A 163 008 012	Rączka dociskowa Hofmann / JBC / Sicam / Bosch / Beissbarth / Nussbaum / ATT / Haweka	148,00 €
	A 163 589 008	Rączka dociskowa Cemb / Hofmann Megaplan / TipTop Probalance	148,00 €
		Bolce centrujące Seria WORLD KIT (Ø 11 mm)	
	A 271 994 117	Bolce przestawne "I" , 100 mm, stożek ostry, Ø 19 mm	24,50 €
	A 271 804 118	Bolce przestawne "II" , 80 mm, stożek płaski, Ø 24,5 mm	24,50 €
	A 271 904 119	Bolce przestawne "III" , 90mm, sferyczne, Ø 24,5 mm	24,50 €
	A 271 804 121	Bolce przestawne "IV" , 80mm, Range/Land Rover, Ø 34 mm	36,00 €
	A 271 994 121	Bolce przestawne "V" 100mm, Ø 22,5 mm	24,50 €
		Bolce specjalne Seria WORLD KIT (Ø 11 mm)	
	A 271 124 102	Bolce przestawne 120 mm, sferyczne, Ø 22,5 mm	24,50 €
	A 271 124 122	Bolce przestawne "VI", 120 mm, Ø 22,5 mm	24,50 €
	A 271 994 308	Bolce przestawne sprężynowe, 100 mm, Ø 24,5 mm	44,00 €
	A 271 008 002	O-Ring do bolców przestawnych Ø 11 mm (5 Sztuk) 7,5 x 2	7,00 €
		Płyty dociskowe Standard (Ø 12 mm)	
		Osobne płyty do bolców stałych, przykręcanych (zalecane bolce 270 804 014)	
		Zamiast XX na 7 i 8 miejscu w numerze należy podać średnicę wałka wyważarki (28, 30, 35, 36, 38, 40)	
	A 250e105 xx0	Płyta dociskowa 5x130 bez bolców >>> prześwit <<<	141,00 €
	A 250e107 xx0	Płyta dociskowa 5x114,3 bez bolców >>> prześwit <<<	141,00 €

Kod	Art.-Nr.	Nazwa	Cena
Płyty pojedyncze Seria Lekkie sam. Cięż., (Ø12mm) bez bolców			
	A 221e201 xx0	Płyta dociskowa 5x160/ 6x180 bez bolców	392,00 €
	A 231e403 xx2	Płyta dociskowa 5x203,2 / 205 / 208 -- 6x184,15 / 222,25	392,00 €
Bolce przykręcane, stałe (Ø 12 mm)			
	A 270 804 003	Bolce przykręcane, stożek płaski 80 mm, Ø 24,5 mm (zalecane bolce standardowe)	24,50 €
	A 270 804 014	Bolce przykręcane, spitz 80 mm lang, Ø 25,4 mm	24,50 €
	A 270 354 000	Bolce przykręcane, 35 mm (Japan), Ø 39,5 mm	24,50 €
	A 270 904 014	Bolce przykręcane, stożek ostry 90 mm, Ø 24,5 mm	24,50 €
	A 270 994 002	Bolce przykręcane, sferyczne 100 mm, Porsche, Ø 24,5 mm	24,50 €
Płyty dociskowe - Serwisy autoryzowane -			
	A 211e201 xx0	Płyta dociskowa 4x100/ 5x120, BMW (konieczne bolce sprężynowe - 271 994 208)	211,00 €
	A 241e304 xx0	Płyta dociskowa 3x112/ 4x100/114,3 Smart (zalecane bolce 271 804 003)	211,00 €
	A 251e208 xx0	Płyta dociskowa 5x112/ 5x120, BMW (konieczne bolce sprężynowe - 271 994 208)	211,00 €
	A 251e511 xx0	Płyta dociskowa 5x98/108/114,3/118 /130 Peugeot/Citroen/Renault (zalecane bolce 271 804 003)	211,00 €
	A 251e510 400	Płyta dociskowa 5x110/112/114,3/120/130, Tesla (zalecane bolce 271 994 003)	211,00 €
	A 260e301 xx0	Płyta dociskowa 6x130 / 6x120 / 6x125 Merceds Benz Sprinter od 01.01.2006 / Iveco / VW Crafter	211,00 €
	A 251e615 xx0	Płyta dociskowa 5x105/ 110/ 115/ 118/ 120/ 130 Opel / Chevrolet bez bolców	211,00 €















Kod	Art.-Nr.	Nazwa	Cena
Płyty pojedyncze (12mm) bez bolców centrujących (zalecane bolce 271 804 003)			
	A 231e301 403	Płyta dociskowa 5x100/ 5x114,3/ 6x139,7 bez bolców	211,00 €
	A 231e401 xx3	Płyta dociskowa Off Road 5x139,7 /5x165,1 / 6x139,7 bez bolców	211,00 €
	A 241e602 xx0	Płyta dociskowa 4x98/ 100/ 108/ 110/ 114,3/ 120 bez bolców	211,00 €
	A 251e603 xx0	Płyta dociskowa 5x 100/ 108/ 112/ 114,3/ 120/ 130 bez bolców	211,00 €
Bolce centrujące do płyt dociskowych (Ø 12 mm)			
	A 271 804 003	Bolce przestawne, stożek płaski 80 mm, Ø 24,5 mm (zalecane bolce standardowe)	24,50 €
	A 271 804 014	Bolce przestawne, stożek ostry 80 mm, Ø 24,5 mm	24,50 €
	A 271 904 012	Bolce przestawne, stożek ostry 90 mm, Ø 24,5 mm	24,50 €
	A 271 994 003	Bolce przestawne, stożek płaski 100 mm, Ø 24,5 mm (Tesla)	24,50 €
	A 271 994 016	Bolce przestawne, stożek ostry 100 mm, Ø 22,5 mm	24,50 €
	A 271 994 025	Bolce przestawne, stożek płaski 100 mm, Ø 22,5 mm	24,50 €
	A 271 994 208	Bolce przestawne, 100 mm - sprężynowe, Ø 24,5 mm	47,00 €
	A 271 008 001	O-Ringi do bolców przestawnych Ø 12 mm (5 Sztuk)	7,00 €
Specjalne bolce centrujące do płyt (Ø 12 mm)			
	A 271 124 002	Bolce przestawne, sferyczne 120 mm, Porsche, Ø 24,5 mm	24,50 €
	A 271 124 009	Bolce przestawne, stożek ostry 120 mm, Ø 24,5 mm	24,50 €
	A 271 994 002	Bolce przestawne, sferyczne 100 mm, Porsche, Ø 24,5 mm	24,50 €















Kod	Art.-Nr.	Nazwa	Cena
QuickPlate V			
QuickPlate			
Zamiast XX na 7 i 8 miejscu w numerze należy podać średnicę wałka wyważarki (28, 30, 35, 36, 38, 40)			
	B 210 400 001	QuickPlate - Zestaw (4-, 5-, 6- bolcowa płyta) z tablicą ścienną	2.556,00 €
	B 210 400 005	QuickPlate - Zestaw (4-, 5- bolcowa płyta) z tablicą ścienną	1.603,00 €
	B 249 012 400	QuickPlate 4- bolcowa płyta ze standardowymi główkami (4 Sztuk 273e008 003)	721,00 €
	B 259 012 400	QuickPlate 5- bolcowa płyta ze standardowymi główkami (5 Sztuk 273e008 007 + 5 Sztuk 273e008 025)	869,00 €
	B 269 012 400	QuickPlate 6- bolcowa płyta ze standardowymi główkami (6 Sztuk 273e008 003)	1.005,00 €
QuickPlate PN Hofmann / JBC / Snap On Powerclamp Sicam / Bosch / Beissbarth / Nussbaum / ATT / Corghi / Mondolfo			
	B 210 818 001	QuickPlate- Zestaw Hofmann (4-, 5-,6- bolcowa płyta z rączką) tablica ścienna	2.816,00 €
	B 249 818 003	QuickPlate 4-bolcowa płyta Hofmann ze standardowymi bolcami (4 x 273e008 003) i rączką	824,00 €
	B 259 818 003	QuickPlate 5-bolcowa płyta Hofmann mit ze standardowymi bolcami (5 x 273e008 025+ 5 x 273e008 007) i rączką	965,00 €
	B 269 818 003	QuickPlate 6-bolcowa płyta Hofmann ze standardowymi bolcami (6 x 273e008 003) i rączką	1.094,00 €
QuickPlate PN Tip Top Probalance / Cemb Ø 40 mm (do wyważarek z uchwytem pneumatycznym)			
	B 210 589 001	QuickPlate- Zestaw Cemb Ø40 mm (4-, 5-,6- bolcowa płyta) tablica ścienna	2.816,00 €
	B 249 589 003	QuickPlate 4-bolcowa płyta Cemb Ø40 mm ze standardowymi główkami (4 x 273e008 003) i rączką	824,00 €
	B 259 589 003	QuickPlate 5-bolcowa płyta Cemb Ø40 mm ze standardowymi główkami (5 x 273e008 025+ 5 x 273e008 007) i rączką	965,00 €
	B 269 589 003	QuickPlate 6-bolcowa płyta Cemb Ø40 mm ze standardowymi bolcami (6 x 273e008 003) i rączką	1.094,00 €



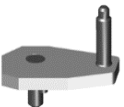

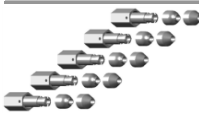







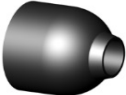

Kod	Art.-Nr.	Nazwa	Cena
Starter-Kitt "samochód osobowy"			
	B 210 400 008	DuoExpert Collte #1,#2, QuickPlate - Zestaw (4-, 5- bolcowa płyta)	2.302,00 €
	B 210 818 008	DuoExpert Collte #1,#2, QuickPlate - Zestaw (4-, 5- bolcowa płyta) Do wyważarek z uchwytem pneumatycznym (Hofmann / JBC / Sicam P / NEXION Group (ELS))	2.482,00 €
	B 210 589 008	DuoExpert Collte #1,#2,#3, QuickPlate - Zestaw (4-, 5- bolcowa płyta) Do wyważarek z uchwytem pneumatycznym (TipTop / Cemb)	2.482,00 €
Główki bolców			
	B 273e008 003	Główka bolca, płaski stożek, Ø 24,5 mm, 38 mm	14,50 €
	B 273e008 007	Główka bolca, sferyczna, Ø 24,5 mm, 48 mm	14,50 €
	B 273e008 009	Główka bolca, Range & Landrover, Ø 34 mm, 38 mm	22,00 €
	B 273e008 023	Główka bolca, ostry stożek, Ø 19,0 mm, 55,6 mm	14,50 €
	B 273e008 025	Główka bolca, ostry stożek, Ø 22,5 mm, length head 58 mm	14,50 €
	B 273e008 028	Główka bolca, ostry stożek, Ø 22,5 mm, length head 73 mm	14,50 €
	B 273e008 029	Główka sferyczna, Ø 24,5 mm, 78 mm	22,00 €

Kod	Art.-Nr.	Nazwa	Cena	
Zestawy adapterów specjalnych Serwisy autoryzowane				
				
Alfa Romeo Lancia	A	280 400 085	Zestaw centrujący	1.088,00 €
BMW / Mini Rolls-Royce	A	280 400 119	Zestaw centrujący BMW 4x100/5x120 + 5x112/120	765,00 €
Chrysler	A	280 400 086	Zestaw centrujący	1.407,00 €
Ferrari	A	280 400 089	Zestaw centrujący	982,00 €
Fiat	A	280 400 090	Zestaw centrujący	1.987,00 €
Ford (EU)	A	280 400 091	Zestaw centrujący	1.692,00 €
Honda	A	280 400 124	Zestaw centrujący	1.115,00 €
Hyundai	A	280 400 093	Zestaw centrujący	1.407,00 €
Jaguar	A	280 400 125	Zestaw centrujący	680,00 €
Kia	A	280 400 095	Zestaw centrujący	732,00 €
Lamborghini (VW)	A	280 400 096	Zestaw centrujący	806,00 €
Land Rover	A	280 400 126	Zestaw centrujący	1.120,00 €
L-Lkw VW / Mercedes	A	280 400 064	Zestaw centrujący	370,00 €
Maserati	A	280 400 097	Zestaw centrujący	1.416,00 €
Mazda	A	280 400 099	Zestaw centrujący	1.256,00 €
Mercedes Pkw Smart	A	280 400 081	Zestaw centrujący	745,00 €
Mercedes Pkw / Lkw	A	280 400 078	Zestaw centrujący	1.276,00 €

	Kod	Art.-Nr.	Nazwa	Cena
Mitsubishi	A	280 400 098	Zestaw centrujący	1.473,00 €
Nissan Infiniti	A	280 400 107	Zestaw centrujący	1.524,00 €
Off Road	A	280 400 073	Zestaw centrujący	1.536,00 €
Opel	A	280 400 080	Zestaw centrujący	817,00 €
Peugeot Citroen	A	280 400 087	Zestaw centrujący	2.176,00 €
Porsche	A	280 400 076	Zestaw centrujący	151,00 €
Porsche	A	280 400 106	Zestaw centrujący 5 x 130 mm	541,00 €
Quad / ATV	A	280 400 055	Zestaw centrujący do felg Quadów	317,00 €
Renault Dacia	A	280 400 079	Zestaw centrujący	728,00 €
Renault Alaskan	A	280 400 150	Zestaw centrujący	509,00 €
Saab Volvo	A	280 400 102	Zestaw centrujący	1.473,00 €
Skoda	A	280 400 137	Zestaw centrujący	1.115,00 €
Subaru	A	280 400 128	Zestaw centrujący	971,00 €
Suzuki	A	280 400 104	Zestaw centrujący	1.088,00 €
Toyota Lexus	A	280 400 129	Zestaw centrujący	1.150,00 €
VW Audi	A	280 400 130	Zestaw centrujący PROFi	1.978,00 €
VW Audi	A	280 400 131	Zestaw centrujący ECO	1.239,00 €
VW Crafter MB Sprinter	A	280 400 061	LLkw Adapter Ø 205	592,00 €
VW Crafter MB Sprinter	A	280 400 122	Zestaw centrujący MB Sprinter / VW Crafter Koła standardowe i bliźniacze	1.443,00 €
L-Lkw "Universal"	A	280 400 151	LLkw Adapter Ø 205 do kół podwójnych	1.595,00 €





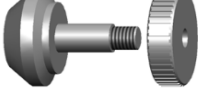





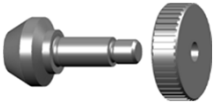



Kod	Art.-Nr.	Nazwa	Cena
Tulejki redukcyjne			
	A 290 280 021	Tulejka redukcyjna 40 mm na 28 mm, dla QuickPlate / WorldKit II / FixPlate II	36,50 €
	A 290 360 021	Tulejka redukcyjna 40 mm na 36 mm, dla QuickPlate / WorldKit II / FixPlate II	36,50 €
	A 290 380 021	Tulejka redukcyjna 40 mm na 38 mm, dla QuickPlate / WorldKit II / FixPlate II	36,50 €
UniLug / Seria 400 + 405			
UniLug Serie 405 (zawiera 3 pierścienie centrujące, 58 ,60, 65 mm)			
	A 405 280 108	UniLug do maszyn z wałkiem 28,56 mm, Mondolfo (<2005), John Bean/Hofmann (> 2014), US-Markt	640,00 €
	A 405 360 108	UniLug do maszyn z wałkiem 36 mm, Cemb, Ravaglioli	640,00 €
	A 405 380 108	UniLug do maszyn z wałkiem 38 mm, Corgi, Faip, Sice, HPA, Toyo Seiki (inkl. pierścieni dystansowy 405e008 004)	640,00 €
	A 405 381 108	UniLug do maszyn z wałkiem 38 mm, Fasep	640,00 €
	A 405 400 108	UniLug do maszyn z wałkiem 40 mm, TipTop, Cemb, Ravaglioli, US-Markt, Mondolfo (2005/06), Hunter 9200	640,00 €
	A 405 401 108	UniLug do maszyn z wałkiem 40 mm, Corgi, HPA, Teco, Mondolfo 01.07 -, (inkl. pierścieni dystansowy 405e008 004)	640,00 €
	A 405 818 108	UniLug do maszyn ze stożkowym łączem, Beissbarth, Sicam, Facom, Hofmann (<2014) + Powerclamp, Schenck / Nussbaum / ATT	680,00 €
	A 803e008 055	Adapter śrubowy M22x1,5 do Fasep z wałkiem Ø 40 mm	81,00 €
	A 405e008 004	UniLug - pierścień dystansowy do Corgi, Faip, Sice, HPA, Mondolfo, TECO	129,00 €
	A 405e280 001	UniLug Adapter Ø 28,56 mm	71,00 €
	A 405e360 001	UniLug Adapter Ø 36 mm	71,00 €
	A 405e380 001	UniLug Adapter Ø 38 mm	71,00 €







	Kod	Art.-Nr.	Nazwa	Cena
	A	405e400 001	UniLug Adapter Ø 40 mm	71,00 €
Pierścienie centrujące Seria 405				
	A	405e009 001	Pierścień centrujący 58 mm	67,50 €
	A	405e009 002	Pierścień centrujący 60 mm	67,50 €
	A	405e009 004	Pierścień centrujący 65 mm	67,50 €
Części zamienne do UniLug / Seria 400 i 405				
	A	405e008 006	Tarcza sterowa UniLug II (sztuczne)	33,00 €
	A	400e008 021	Skrzydółko für UniLug (Seria 405)	87,00 €
	A	400e008 050	Śruba pasowania UniLug II (Serie 405) wysokość główki 3,2 mm	19,50 €
	A	400e008 027	Nakrętka radełkowa do skrzydółka 400e008 041	11,50 €
	A	400e008 041	Skrzydółko do UniLug (Seria 400 stożkowy)	87,00 €
	A	490 008 000	Suwmiarka do UniLug	44,00 €
	B	490 008 002	Miernik średnicy podziałowej	49,00 €
Nakrętki i Fixstożki				
	A	040 100 001	Zestaw Fixstożków (5 Sztuk) M10x1,25 mm (Haweke)	292,00 €
	A	040 100 002	Zestaw Fixstożków (5 Sztuk) M10x1.5 mm (Corghi/Cemb)	292,00 €
	A	040 100 003	Fixstożek M10x1.25 mm (Haweke)	71,00 €
	A	040 100 004	Fixstożek M10x1.5 mm (Corghi/Cemb)	71,00 €

Kod	Art.-Nr.	Nazwa	Cena
	A 040 100 102	Nakrętka M10x1.25 mm, stożek i kula (Haweka) (1 Sztuka)	11,50 €
	A 040 100 112	Nakrętka M10x1,25 mm extra długa, kula i stożek	13,50 €
	A 040e008 004	Główka Fixstożka, kula	13,50 €
	A 040e008 005	Główka Fixstożka, stożek	13,50 €
Uchwyty do kół samochodów ciężarowych			
Zestawy			
	A 700 400 211	Lkw Adapter Kit Ø 40mm 19,5" / 22,5" Europa Beissbarth, Cemb, Hofmann	1.571,00 €
	A 700 400 213	Lkw Adapter Kit Ø 40mm 19,5" / 22,5" Europa Hunter	1.571,00 €
	A 700 818 172	Lkw Adapter Kit Hofmann / JBC / stożkowy Tr 40x4	1.694,00 €
	A 700 905 174	Lkw Adapter Kit Corgi, Faip, Sice, Mondolfo / Teco (Tr 46 x 6)	1.694,00 €
	A 702 818 172	Zestaw dla lekkich i ciężkich samochodów ciężarowych do wyważarek ze stożkowym łączem Tr 40x4	2.189,00 €
	A 705 589 172	Lkw/Leicht-Lkw Adapter Kit Cemb, Hofmann, JBC, Ravaglioli, Cormach Tr 40x4	2.250,00 €
Uchwyty do samochodów ciężarowych - części pojedyncze			
	A 700 008 003	Bolec centrujący & nakrętka (standard)	41,00 €
	A 700 008 004	Bolec centrujący & nakrętka (Dynaf)	41,00 €
	A 700 008 037	Bolec centrujący & nakrętka (IFA)	41,00 €
	A 700 008 006	Bolec centrujący & nakrętka (Felgi ALU)	41,00 €
	A 700 008 013	Bolec centrujący & nakrętka (Gwiazda 3-ramienna Japan)	41,00 €

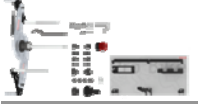
-- ** -- = Cena do uzgodnienia
A B C D N = Grupy rabatowe

















V1.0 2022

	Kod	Art.-Nr.	Nazwa	Cena
	A	700 008 018	Bolec centrujący & nakrętka (Gwiazda 3-ramienna Europe)	41,00 €
	A	700 008 025	Bolec centrujący & nakrętka (Gwiazda 3-ramienna Europe) MB Sprinter / CW Crafter new	41,00 €
	A	700 008 030	Bolec centrujący & nakrętka (Gwiazda 3-ramienna Europe) MB Sprinter / CW Crafter new długi	46,50 €
	A	700 400 039	Gwiazda 5-ramienna LK: 225 / 285,75 / 335 mm	519,00 €
	A	700 400 040	Gwiazda 4-ramienna LK: 275 / 285 mm	416,00 €
	A	700 400 021	Gwiazda 3-ramienna, LK 170 / 184,15 / 200 / 205 / 222,25 / 245	335,00 €
	A	700e618 012	Flansza Hunter Ø 40 mm	502,00 €
	A	700e905 012	Flansza Corgi/Faip/Sice Ø 46 mm	502,00 €
	A	700e958 012	Flansza John Bean/Hofmann, Sicam, Cemb, Beissbarth Ø 40 mm	502,00 €
	A	700e958 113	Flansza II US Ø 40 mm	502,00 €
	A	70Be958 007	Pierścień centrujący 220.8 mm	290,00 €
	A	70Be958 008	Pierścień centrujący 219.9 mm	290,00 €
	A	700e798 009	Pierścień centrujący 202 mm	290,00 €
	A	700 818 181	Zestaw centrujący LKW 19,5 MB Atego / Iveco Eurocargo	597,00 €
	A	700 818 182	Zestaw centrujący LKW 17,5 Adapterkit MB Atego	597,00 €

Kod	Art.-Nr.	Nazwa	Cena
Uchwyty motocyklowe ProBike			
Uchwyty motocyklowe ProBike III / Serie 815			
	A 815 818 010	ProBike III Modul Uni (stożkowy) + tablica ścienna 900 008 142 (Hofmann PowerClamp)	1.150,00 €
	A 815 281 010	ProBike III Modul Uni (cylindryczny 28 mm) + tablica ścienna	1.150,00 €
	A 815 361 010	ProBike III Modul Uni (cylindryczny 36 mm) + tablica ścienna	1.150,00 €
	A 815 381 010	ProBike III Modul Uni (cylindryczny 38 mm) + tablica ścienna	1.150,00 €
	A 815 401 010	ProBike III Modul Uni (cylindryczny 40 mm) + tablica ścienna	1.150,00 €
	A 815 401 024	ProBike III Modul Uni (cylindryczny 40 mm fasep 2010-) + tablica ścienna	1.150,00 €
ProBike III - Upgrade zestaw			
	A 815 008 002	ProBike III doposażenie, 19mm wałek, QuickFix, zestaw tulejek, tablica ścienna 900 008 143	588,00 €
	A 815 008 003	ProBike III doposażenie Profi / 19mm do wahaczy jednoramiennych	905,00 €
Części pojedyncze / Akcesoria			
	A 840e100 001	Nakrętka radełkowa M10 do wałków 10 i 12 mm	11,50 €
	A 840e140 001	nakrętka radełkowa M14 do wałków 14 mm i większych	11,50 €
	A 890 140 001	Bike Clamp - Quick Fix do 14 mm wałków	170,00 €
	A 890 190 001	Bike Clamp - Quick Fix do 19 mm wałków	170,00 €
Części pojedyncze / Pozycje motocykl ProBike Seria 815			
	A 803e999 002	Adapter stożkowy ProBike 815 Hofm. Geodyna"\"P\" zawiera śruby mocujące	172,00 €













-- ** -- = Cena do uzgodnienia
A B C D N = Grupy rabatowe

V1.0 2022

	Kod	Art.-Nr.	Nazwa	Cena
	A	803e008 041	Adapter ø28,57 ProBike 815 L=60,5mm, zawiera śruby mocujące	172,00 €
	A	803e008 042	Adapter ø 36 ProBike 815 L=60,5mm, zawiera śruby mocujące	172,00 €
	A	803e008 043	Adapter ø 38 ProBike 815 L=60,5mm, zawiera śruby mocujące	172,00 €
	A	803e008 044	Adapter ø 40 ProBike 815 L=60,5mm, zawiera śruby mocujące	172,00 €
	A	803e008 027	Komplet zabieraków, zestaw zamienny (Para) Serie 815	274,00 €
	B	DU GA 150252250	Amortyzator gazowy Serie 815 (250 N)	70,00 €
	A	870 012 140	14 mm Wałek, długość 270 mm	207,00 €
	A	870 012 141	14 mm Wałek, długość 329 mm	301,00 €
	A	870 012 190	19 mm Wałek, długość 300 mm	207,00 €
	A	870 012 191	19 mm Wałek, długość 365 mm	301,00 €
Części pojedyncze / Akcesoria ProBike II Serie 805				
	A	800e999 004	Adapter do ProBike stożkowy	235,00 €
	A	803e008 003	Adapter do ProBike Ø 28,56 mm	172,00 €
	A	803e008 006	Adapter do ProBike Ø 36 mm	172,00 €
	A	803e008 007	Adapter do ProBike Ø 38 mm	172,00 €
	A	803e008 008	Adapter do ProBike Ø 40 mm	172,00 €
	A	803e008 015	Adapter do ProBike Ø 40 mm, lange Version, Corgi, Mondolfo, Teco, HPA ab 01/07, Sice	172,00 €

-- ** -- = Cena do uzgodnienia
A B C D N = Grupy rabatowe

V1.0 2022

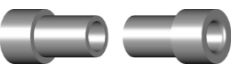
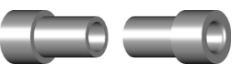
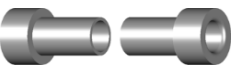
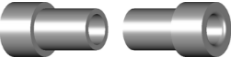
Kod	Art.-Nr.	Nazwa	Cena
	A 803e008 055	Adapter śrubowy M22x1,5 do Fasep z wałkiem Ø 40 mm	81,00 €
	A 803e008 030	ProBike, skrzydło kompletne	497,00 €
	A 803e008 010	Zabierak - zestaw zamienny(Para)	274,00 €
	B DU GA 150209350	Amortyzator gazowy Seria 805 (350 N)	83,00 €
Części pojedyncze / Seria 802 + 805			
	A 850e190 007	Stożek Polyamid / Docisk, dla wałka 19 mm	29,50 €
	A 850 140 006	Zestaw 2 stożków, zakres 16 - 45 mm	71,00 €
	A 850e140 001	Stożek do wałków 14 mm (14,2 - 30 mm)	14,50 €
	A 860 008 007	Zestaw tulejek 15-28 mm, do wałków 14 mm	245,00 €
	A 860 008 008	Zestaw specjalnych tuleii centrujących bez wałka 19 mm	866,00 €
	A 860 008 009	Zestaw centrujący BMW, 2 tuleje i 2 dociski	321,00 €
	A 860 140 015	Zestaw centrujący BMW (do 2005), tuleja, docisk do wałka Ø 14 mm	162,00 €
	A 860 190 026	Zestaw centrujący KAWASAKI H2 - tylne koło (do 2015)	341,00 €
	A 860 140 150	Zestaw tulejek 15 mm	31,00 €
	A 860 140 160	Zestaw tulejek 16 mm	31,00 €
	A 860 140 170	Zestaw tulejek 17 mm	31,00 €
	A 860 140 190	Zestaw tulejek 19 mm	31,00 €















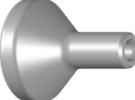

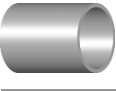
-- ** -- = Cena do uzgodnienia
A B C D N = Grupy rabatowe

V1.0 2022

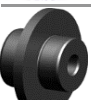
	Kod	Art.-Nr.	Nazwa	Cena
	A	860 140 200	Zestaw tulejek 20 mm	31,00 €
	A	860 140 220	Zestaw tulejek 22 mm	31,00 €
	A	860 140 250	Zestaw tulejek 25 mm	31,00 €
	A	860 140 261	Zestaw tulejek 26 mm	31,00 €
	A	860 140 280	Zestaw tulejek 28 mm	31,00 €
	A	860 140 300	Zestaw tulejek 30 mm	31,00 €
	A	860 190 007	Adapter Kit HARLEY DAVIDSON, Ø 19 mm	14,50 €
	A	860 190 009	Adapter Kit SUZUKI GSX R; Tuleje 25, 28, 32 mm, Ø 19 mm	116,00 €
	A	860 190 012	Tuleja Aprilia RST Futura; BMW F 650 CS, Ø 19 mm	104,00 €
	A	860 190 014	Tuleje Harley Davidson V Rod, Ø 25,4 mm	49,00 €
	A	860 190 020	Zestaw centrujący BMW (od 2005) + R 1200 GS , tuleja, docisk do wałka Ø 19mm	182,00 €
	A	860 190 220	Zestaw 22 mm tuleji centrujących (19 mm oś)	49,00 €
	A	860 190 250	Zestaw 25 mm tuleji centrujących (19 mm oś)	49,00 €
	A	860 190 261	Zestaw 26 mm tuleji centrujących (19 mm oś)	49,00 €
	A	860 190 280	Zestaw 28 mm tuleji centrujących (19 mm oś)	49,00 €
	A	860 190 300	Zestaw 30 mm tuleji centrujących (19 mm oś)	49,00 €









-- ** -- = Cena do uzgodnienia
A B C D N = Grupy rabatowe

V1.0 2022

	Kod	Art.-Nr.	Nazwa	Cena
	A	860 190 320	Zestaw 32 mm tuleji centrujących (19 mm oś))	49,00 €
	A	860 190 350	Zestaw 35 mm tuleji centrujących (19 mm oś)	49,00 €
	A	860e120 002	Tuleja dystansowa, krótka 12 mm Ø wewnątrz	11,50 €
	A	860e140 015	Tuleja do BMW 14 mm, tylne koło (wahacz jednoramienny) do 2005 r. poza RS 1200 GS	141,00 €
	A	860e140 006	Polyamidowy docisk Honda / BMW 14 mm	33,00 €
	A	860e140 460	Tuleja do rozmaity Piaggio / Vespa	124,00 €
	A	860e150 002	Tuleja dystansowa, krótka 15 mm Ø wewnątrz	11,50 €
	A	860e180 002	Tuleja dystansowa, krótka 18 mm Ø wewnątrz	11,50 €
	A	860e190 004	Adapter Ducati monolever, 19 mm	124,00 €
	A	860e190 018	Adapter HONDA: NTV 650, Goldwing 1800 (Ø 19 mm)	124,00 €
	A	860e190 011	Tuleja MV Agusta / Honda VFR 800 (Ø 19 mm)	124,00 €
	A	860e190 012	Tuleja centrująca APRILIA / BMW / YAMAHA do wałka 19 mm	124,00 €
	A	860e190 020	Tuleja do BMW	162,00 €
	A	860e190 022	Tuleja TRIUMPH (>= 2011) i KTM	120,00 €
	A	860e190 023	Tuleja Triumph Speed Triple 1200 RS >= 2021	124,00 €
	A	860e190 024	Tuleja TRIUMPH, HONDA VFR 1200 (od roku 2010)	124,00 €

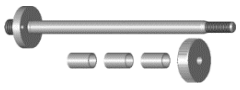
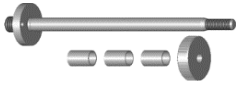
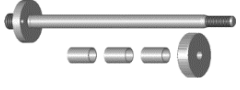
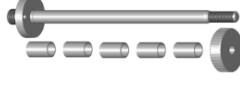
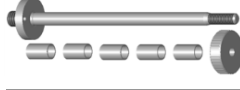
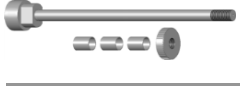













-- ** -- = Cena do uzgodnienia
A B C D N = Grupy rabatowe

V1.0 2022

Kod	Art.-Nr.	Nazwa	Cena
	A 860e190 025	Tuleja centrująca HONDA VFR 1200X do wałka 19 mm	124,00 €
	A 860e200 002	Tuleja dystansowa, krótka 20 mm Ø wewnątrz	11,50 €
	A 860e250 002	Tuleja dystansowa, krótka 25 mm Ø wewnątrz	11,50 €
	A 860e280 002	Tuleja dystansowa, krótka 28 mm Ø wewnątrz	11,50 €
	A 990e008 001	Klucz hakowy do nakrętek radełkowych i wałków	14,50 €
Wałki uchwytów motocyklowych pasujące do 805 280 000 - 805 400 000			
	A 870 010 120	12 mm wałek, długość 193 mm	197,00 €
	A 870 010 140	14 mm wałek, długość 233 mm	197,00 €
	A 870 010 141	14 mm wałek, długość specjalna 318 mm	295,00 €
	A 870 010 190	19 mm wałek, długość 270 mm	197,00 €
	A 870 010 191	19 mm wałek, długość 365 mm	324,00 €
Wałki motocyklowe - Hofmann Power Clamp Seria 805			
	A 870 995 140	14 mm wałek Hofmann Geodyna Power Clamp, 253 mm	295,00 €
	A 870 995 190	19 mm wałek Hofmann Geodyna Power Clamp, 270 mm	295,00 €
Wałki motocyklowe - stożkowe łącza, Seria 805			
	A 870 997 140	14 mm wałek do stożkowego łącza, długość 233 mm	197,00 €
	A 870 997 141	14 mm wałek do stożkowego łącza, długość specjalna 302 mm	295,00 €







-- ** -- = Cena do uzgodnienia
A B C D N = Grupy rabatowe

V1.0 2022

Kod	Art.-Nr.	Nazwa	Cena
	A 870 997 190	19 mm wałek do stożkowego łącza, długość 270 mm	197,00 €
	A 870 997 191	19 mm wałek do stożkowego łącza, długość 365 mm	324,00 €
Wyposażenie warsztatowe			
Podnośniki			
	B 916 000 017	AirgoLift II, Podnośnik kół do wyważarek	1.525,00 €
	N 916 001 127	AirgoLift Zestaw do konwersji Hofmann	150,00 €
	N 916 001 128	AirgoLift Zestaw do konwersji Hunter	71,00 €
	B 916 001 164	Części zamienne do AirgoLift rolek	26,50 €
Akcesoria			
	A 900 008 027	Przyrząd do pomiarów felg i uchwytów wyważarek/ Zegar 1,0 mm	1.214,00 €
	A 900 008 030	Model demonstracji niewyważań	184,00 €
	N 900 008 074	Wzorzec do średnic wewnętrznych 28 / 36 mm	84,00 €
	N 900 008 075	Wzorzec do średnic wewnętrznych 38 / 40 mm	84,00 €
	N 900 008 076	Zestaw wzorników	462,00 €
	N 900 008 103	Wzornik do wałków 28/36mm	168,00 €
	N 900 008 104	Wzornik do wałków 38/40mm	168,00 €
	A 900 008 128	Wózek do uchwytów-TROLLEY ze sforzniami \varnothing 40 mm	194,00 €
	A 900 008 232	Tablica ścienna "Off Road"	143,00 €

-- ** -- = Cena do uzgodnienia
A B C D N = Grupy rabatowe

V1.0 2022

	Kod	Art.-Nr.	Nazwa	Cena
	A	900 008 142	Tablica ścienna ProBike II + III "Standard"	143,00 €
	A	900 008 143	Tablica ścienna ProBike II + III "Profi"	143,00 €
	A	900 008 230	Tablica ścienna QuickPlate	143,00 €
	A	900 008 231	Tablica ścienna WorldKitt II	143,00 €
	A	900 008 148	Wirnik wzorcowy do wyważarek w walizce	2.325,00 €
	A	900e008 011	Miernik zegarowy 1 mm	442,00 €
	C	900e008 190	Stojak na tablice (bez tablic)	91,00 €



HAWEKA AG

Kokenhorststr. 4 ♦ 30938 Burgwedel

☎ +49 5139-8996-0 📠 +49 5139-8996-222

www.haweke.com ♦ Info@haweke.com